

# CYCLONE 2 - Assembly

- 1 Use the packing box to rest the frame on during assembly. Remove the packaging from the spigots - Do NOT remove the protective wrap until step 5

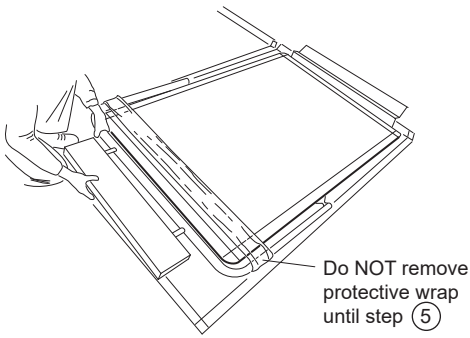

- 2 Offer the base to the frame, aligning the spigots of the frame with the holes in the base.

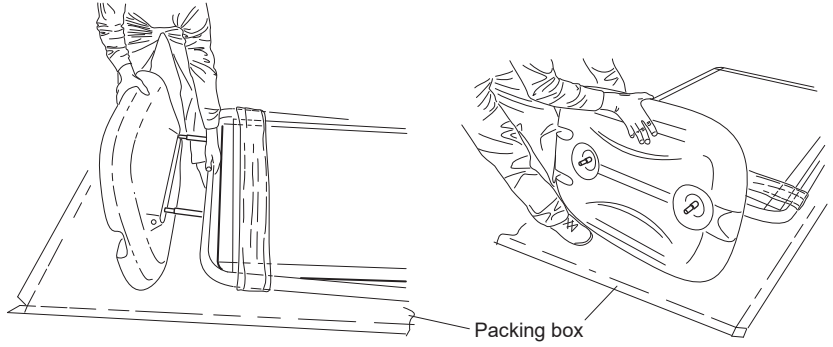

- 3 Locate large flat washers, small spring washers & wingnuts onto spigots. NB Both wingnuts MUST be fully tightened.

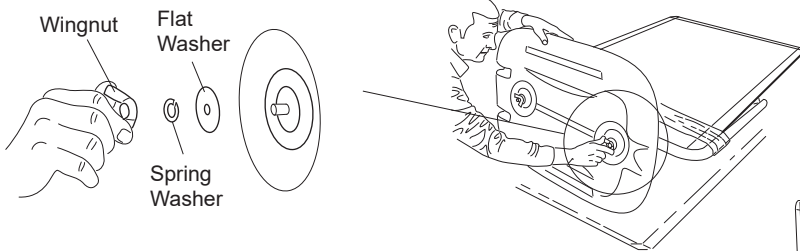

- 4 Carefully guide the assembled sign upright.

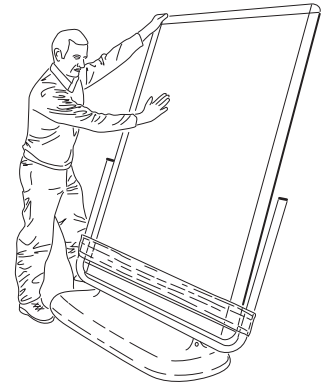

- 5 Cut through the & discard the protective wrap.

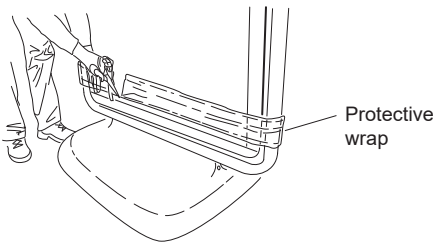

- 6 Using the metal angle tool, remove the plug & fill the base with water. Until base is overflowing (Approx 7 mins). Replace the plug.

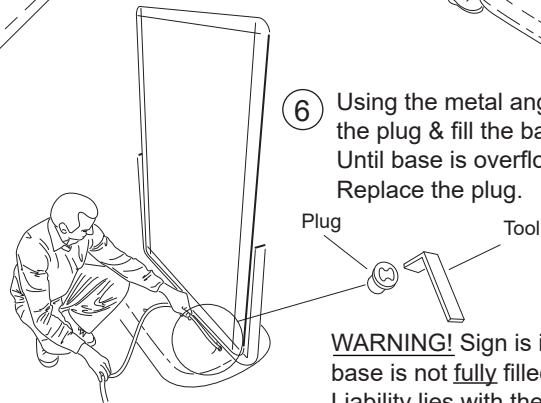

**WARNING!** Sign is at risk of falling if base is not fully filled. Liability lies with the user.

## Poster Insertion/Change

- 1 Open the bottom & side trims. Tip the frame forward to release the cover sheet from the bottom corners.

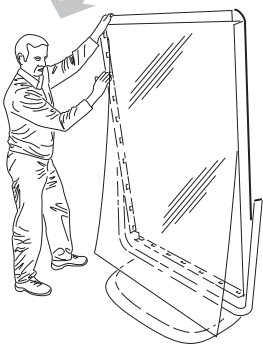

- 2 Rotate the frame to level. Pull back the cover sheet. Slide the poster into position. Two person operation recommended.

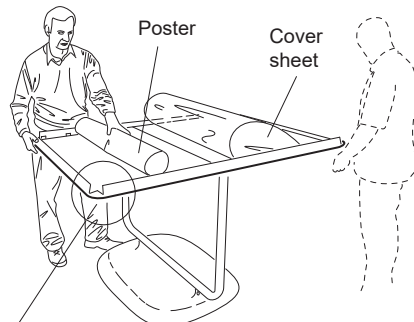

- 3 Rotate the frame back to vertical.

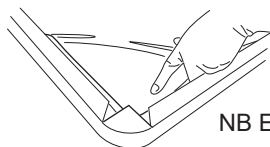
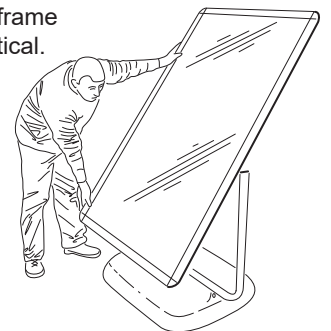

NB Ensure poster & cover sheet locate under corners before closing the trim.



To avoid damage to the underside of the base we recommend that a trolley is used to move the sign to your desired location.

**Incorrect moving method.**

